

CABRIOLETTE

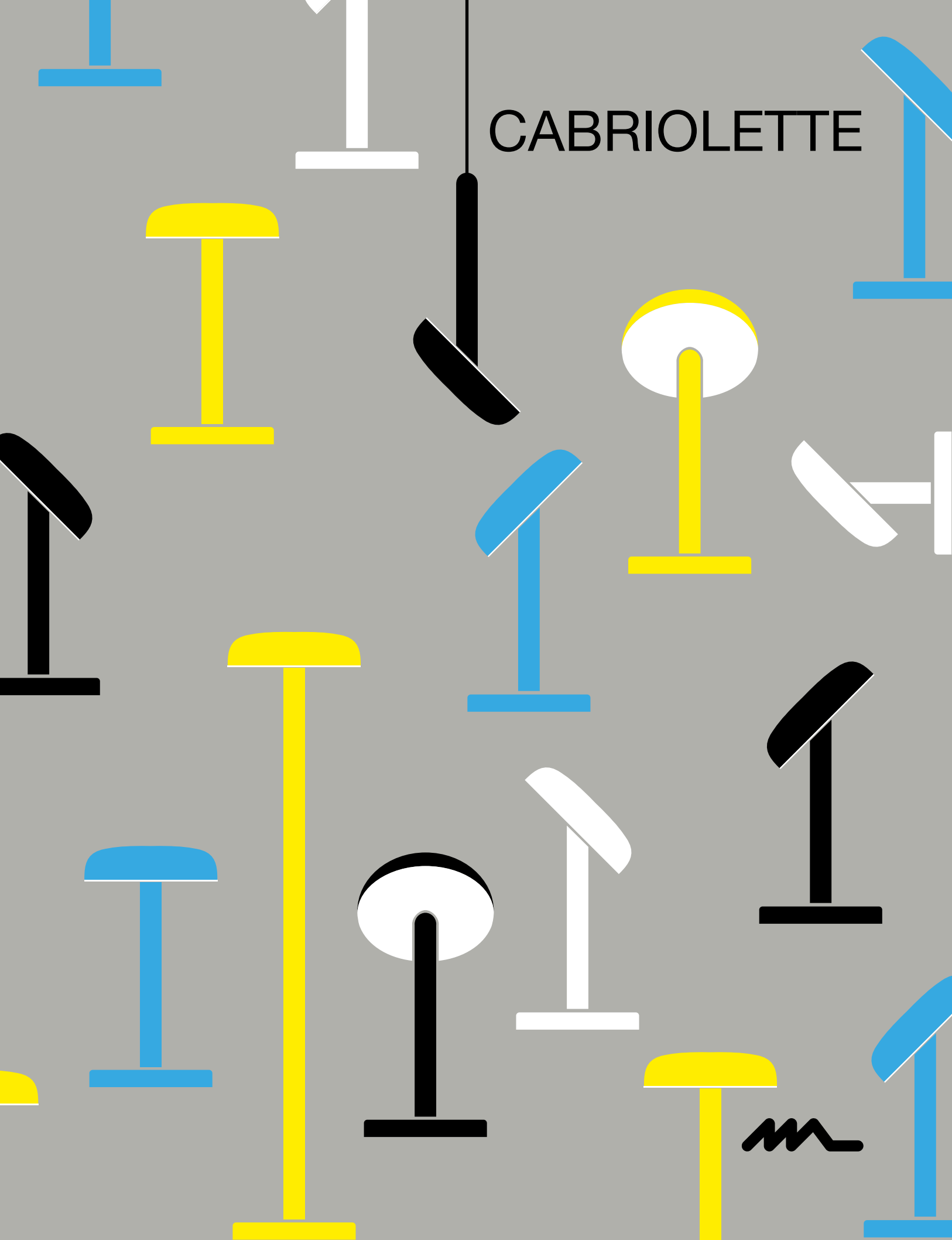



# CABRIOLETTE

STUDIO NATURAL



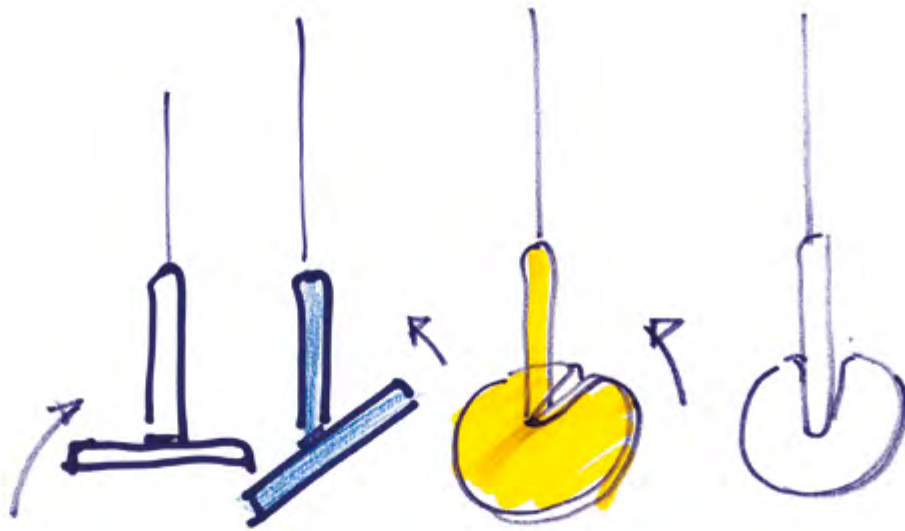

CABRIOLETTE  
 SOSPESA  
 PARETE  
 TAVOLO  
 TERRA

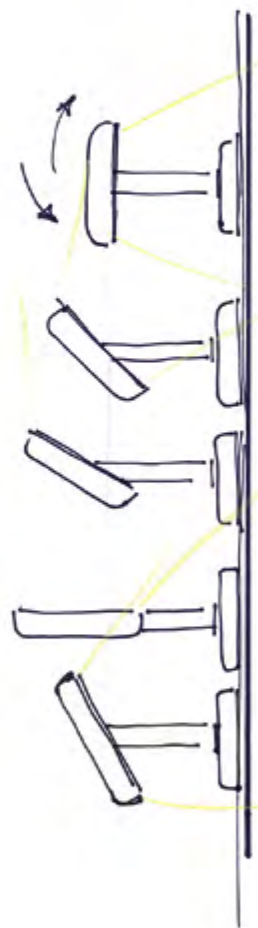
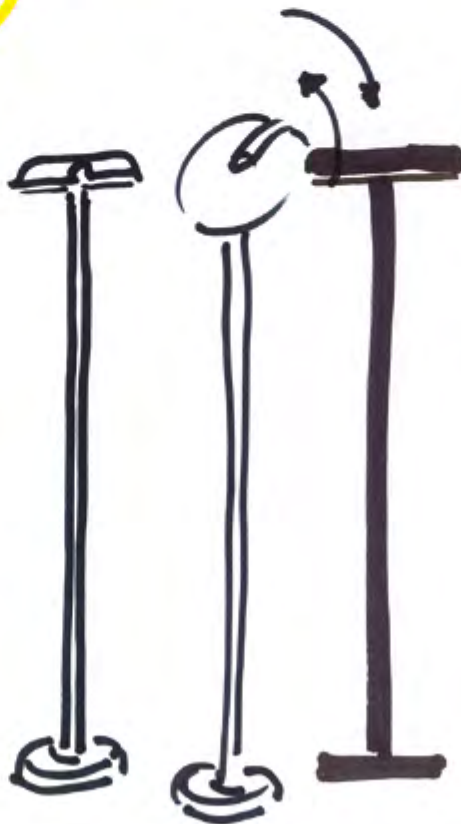



## CABRIOLETTE

Piccola, orientabile, funzionale, rotonda e giocosa.  
Il riflettore si orienta e si muove a ricordare una cabriolet.  
Appoggiata sulla scrivania, in camera vicina al letto, da lettura vicino al divano.  
Disponibile nelle versioni da tavolo, cordless, a parete, da terra e a sospensione.

Small, adjustable, functional, circular and playful.  
The reflector swivels and moves to recall a cabriolet.  
Placed on the desk, in the bedroom next to the bed, for reading next to the sofa.  
Available in table, cordless, wall, floor and suspension versions.

## STUDIO NATURAL

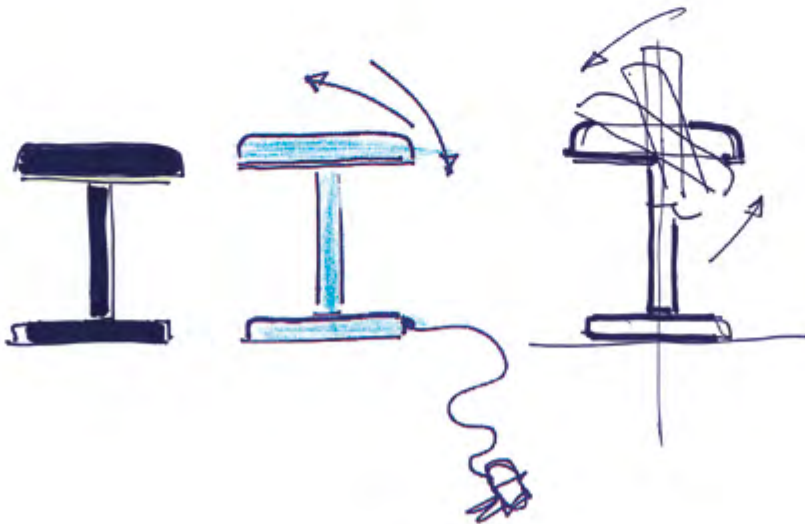

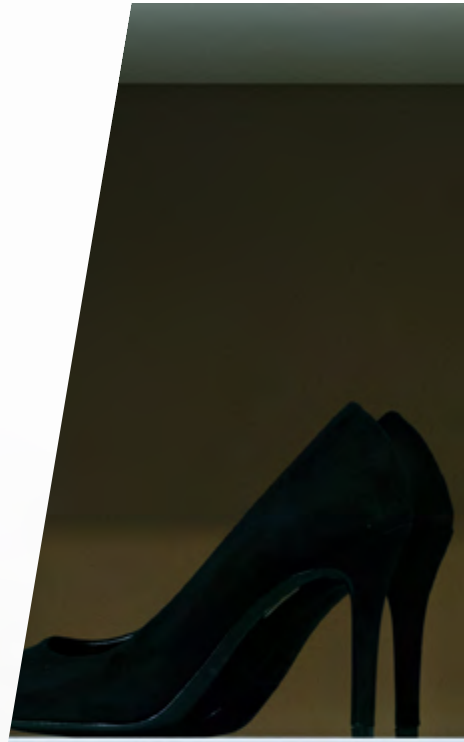



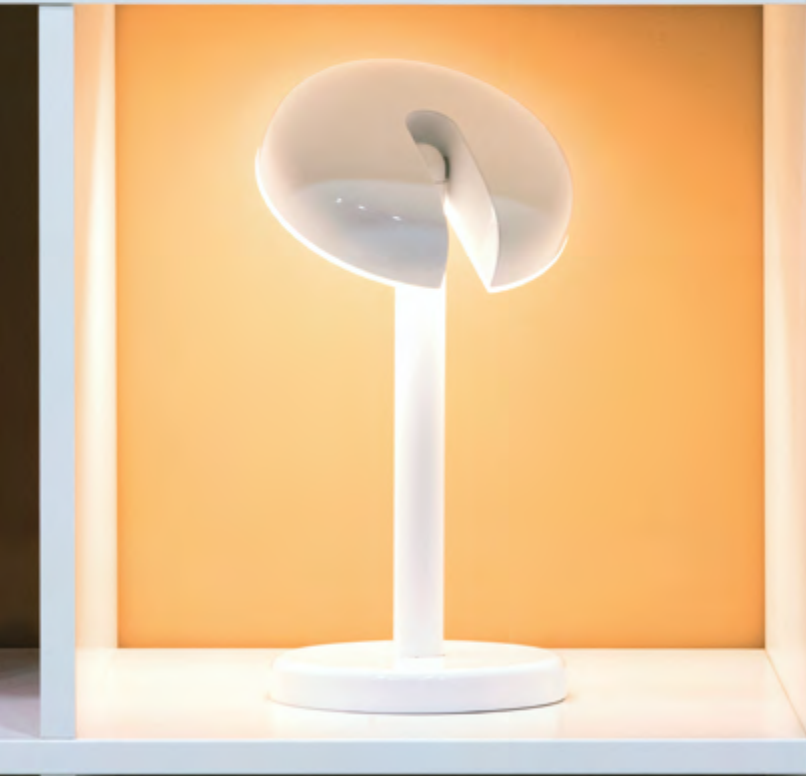



















## CABRIOLETTE table / cordless

Lampada da tavolo a luce diretta orientabile.  
Struttura in pressofusione di alluminio verniciato nei colori bianco, nero, giallo e azzurro.  
Diffusore in policarbonato opal bianco.  
Sorgente di luce a LED integrata.  
Dimmerabile con pulsante sul cavo.  
Alimentatore a spina.

Table lamp providing direct adjustable light.  
Aluminium die-cast structure painted in white, black, yellow and light blue.  
White opal polycarbonate diffuser.  
Integrated LED light source.  
Dimmable with button on cable.  
Driver on the plug.

7W 1119lm 2700K

- 832/BI  bianco / white
- 832/NE  nero / black
- 832/GI  giallo / yellow
- 832/AZ  azzurro / light blue



### CORDLESS

Dimmerabile con pulsante touch sulla base.  
Batteria ricaricabile con cavetto USB-C incluso senza caricabatteria, durata 8 ore, batteria fornita.  
Caricabatteria USB da ordinare a parte.

Dimmable with touch button on the base.  
Rechargeable battery with USB-C cable included, duration 8 hours, battery supplied.  
USB charger to be ordered separately.

1,5W 220lm 2700K

- 832/CL/BI  bianco / white
- 832/CL/NE  nero / black
- 832/CL/GI  giallo / yellow
- 832/CL/AZ  azzurro / light blue

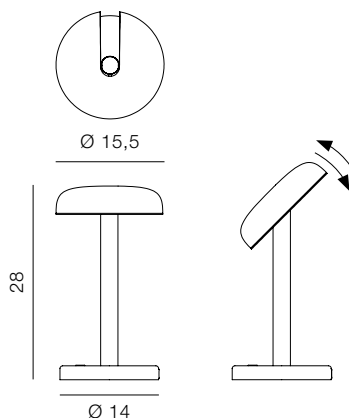

40065 caricabatteria USB-C / USB-C charger



## CABRIOLETTE wall

Lampada da parete a luce indiretta con riflettore orientabile.

Struttura in pressofusione di alluminio verniciato nei colori bianco e nero.

Diffusore in policarbonato opal bianco.

Sorgente di luce a LED e alimentatore integrati.

Indirect light wall lamp with adjustable reflector.

Die-cast aluminium structure painted in white and black.

White opal polycarbonate diffuser.

Integrated LED light source and driver.

14W LED 2200lm 2700K

1442/BI ○ bianco / white

1442/NE ● nero / black

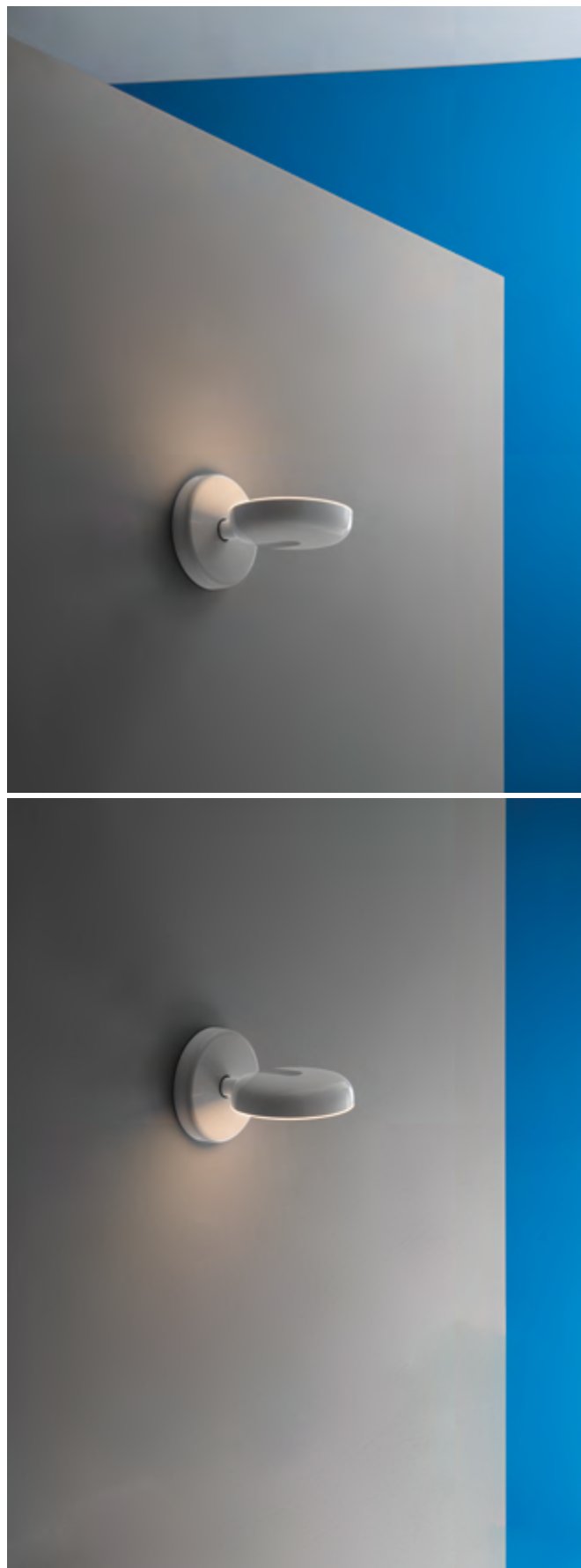
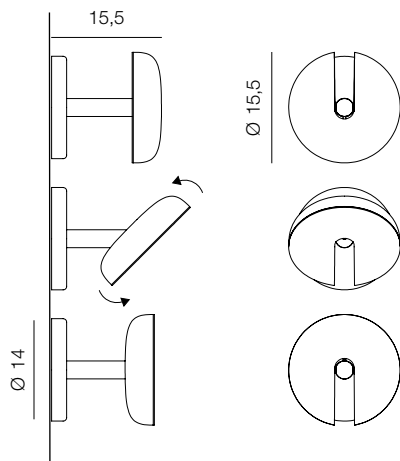





## CABRIOLETTE floor

Lampada da terra a luce diretta orientabile.  
Struttura in pressofusione di alluminio verniciato nei colori bianco, nero, giallo e azzurro.  
Diffusore in policarbonato opal bianco.  
Sorgente di luce a LED integrata.  
Dimmerabile con pulsante sul cavo.  
Alimentatore a spina.

Floor lamp providing direct adjustable light.  
Aluminium die-cast structure painted in white, black, yellow and light blue.  
White opal polycarbonate diffuser.  
Integrated LED light source.  
Dimmable with button on cable.  
Driver on the plug.

14W 2200lm 2700K

2319/BI ○ bianco / white

2319/NE ● nero / black

2319/GI ● giallo / yellow

2319/AZ ● azzurro / light blue

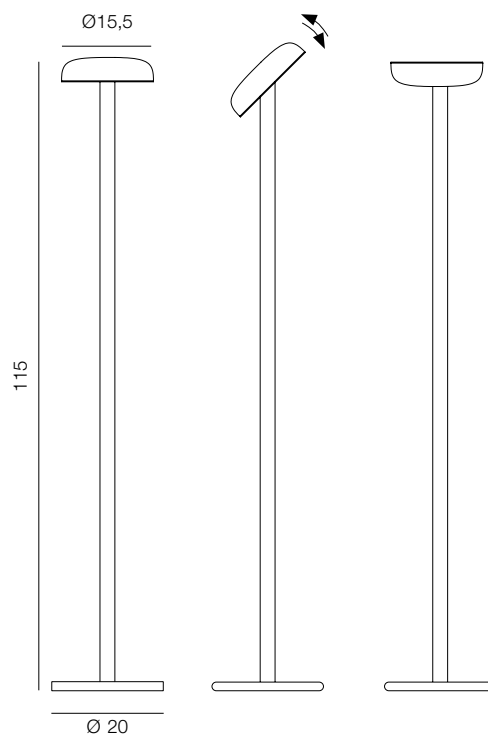





## CABRIOLETTE suspension

Lampada a sospensione a luce diretta orientabile.  
Struttura in pressofusione di alluminio verniciato nei colori bianco, nero, giallo e azzurro.  
Diffusore in policarbonato opal bianco.  
Sorgente di luce a LED integrata.  
Alimentatore nel rosone al soffitto.

Suspension lamp providing direct adjustable light.  
Aluminium die-cast structure painted in white, black, yellow and light blue.  
White opal polycarbonate diffuser.  
Integrated LED light source.  
Driver inside the ceiling rose.

7W 1119lm 2700K

- 21020/BI ○ bianco / white
- 21020/NE ● nero / black
- 21020/GI ● giallo / yellow
- 21020/AZ ● azzurro / light blue

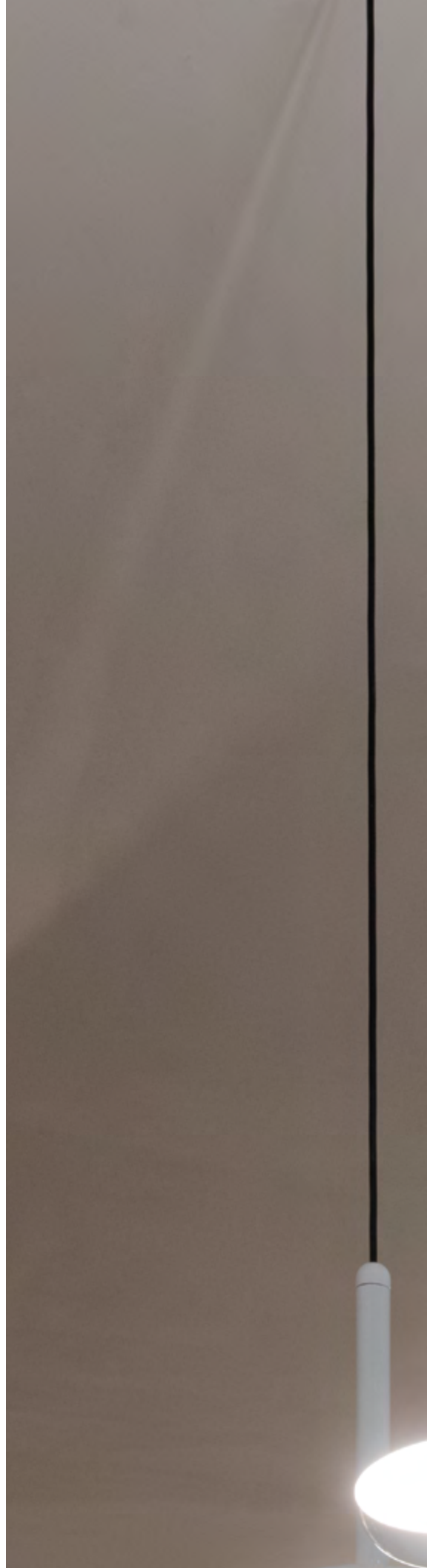
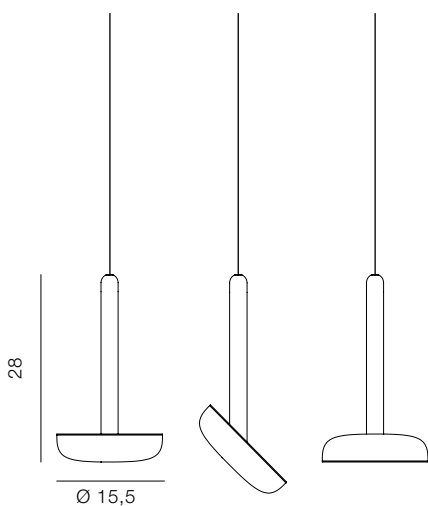



**MARTINELLI LUCE** si riserva il diritto di apportare ai propri modelli in ogni momento senza nessun preavviso, qualsiasi modifica ritenesse opportuna.

**MARTINELLI LUCE** reserves the right to introduce any changes to its own models, without prior notice.



**martinelli luce spa** | via Teresa Bandettini, Lucca | +39 0583 418315  
[www.martinelliluce.it](http://www.martinelliluce.it) | [info@martinelliluce.it](mailto:info@martinelliluce.it)  
showroom | via santa Lucia 9, Lucca | [showroom@martinelliluce.it](mailto:showroom@martinelliluce.it)







**martinelli luce**

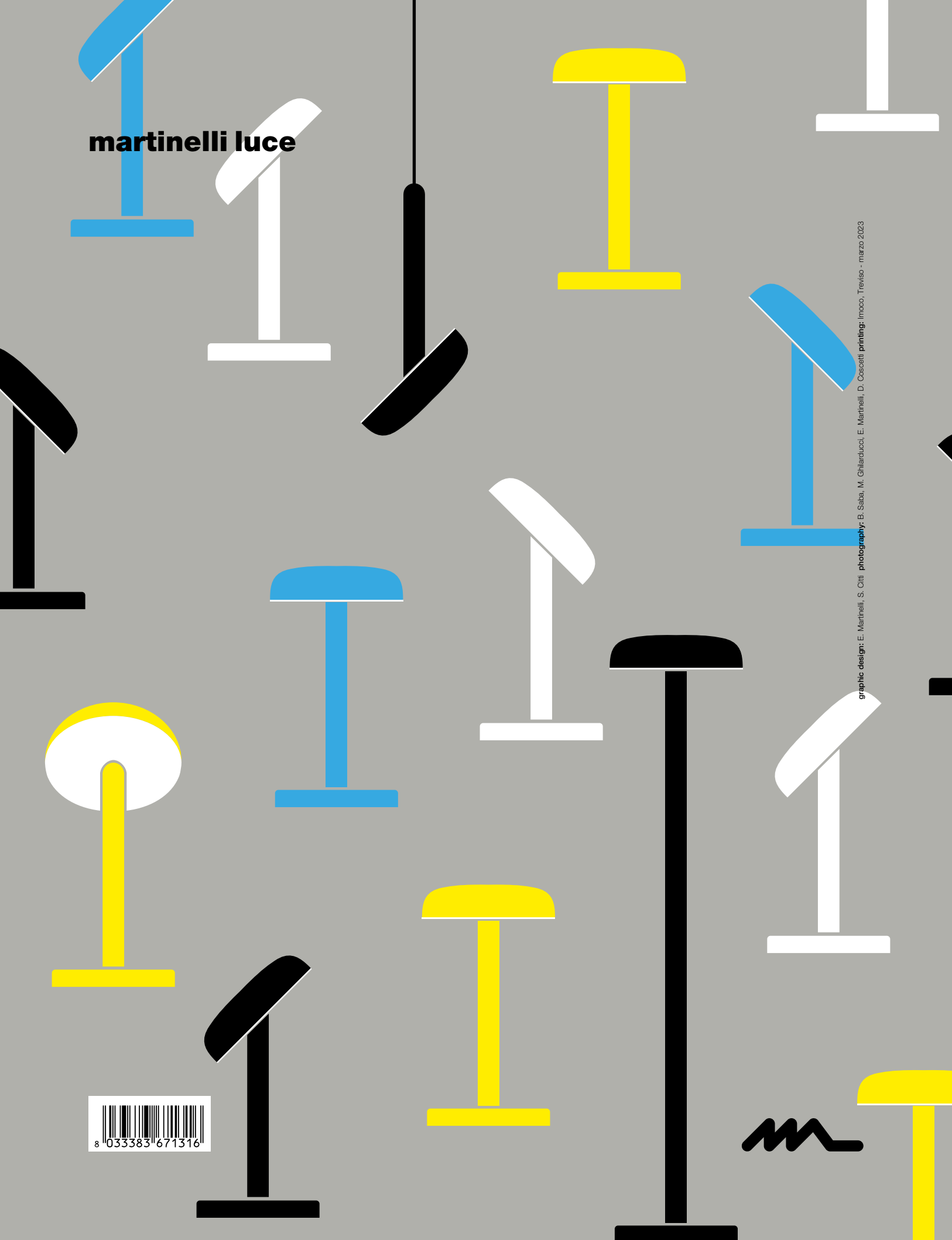

graphic design: E. Martinelli, S. Citi photography: B. Saba, M. Ghiarducci, E. Martinelli, D. Coscetti printing: Imoco, Treviso - marzo 2023

