

PIPISTRELLO
code: **620/AL**



DESIGN **GAE AULENTI** 1965

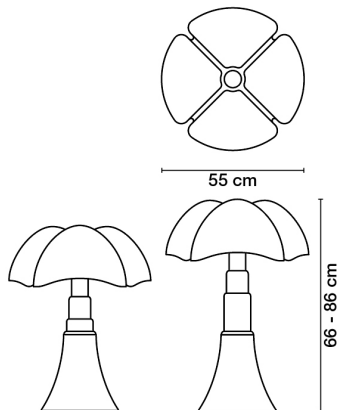

TABLE OR STANDING LAMP WITH DIFFUSED LIGHT, ADJUSTABLE HEIGHT WITH TELESCOPIC MOVEMENT. DIFFUSER IN WHITE OPAL METHACRYLATE. STAINLESS STEEL TELESCOPE. PAINTED METAL BASE AND KNOB IN DARK BROWN /MA, WHITE /BI, PURPLE RED /RO, GLOSSY BLACK /NE AND SATIN ALUMINIUM /AL. DESIGNED IN 1965 BY GAE AULENTI FOR MARTINELLI LUCE, THE LAMP IS MADE WITH INNOVATIVE TECHNIQUES FOR THE DIFFUSER IN METHACRYLATE FOR THE TIME IN WHICH IT WAS DESIGNED. THE SHAPE OF CONIC BASE GROWS IN THE HEIGHT THROUGH THE RIBS OF THE DIFFUSER AS THE WINGS OF A BAT. RESTING ON A TABLE OR STANDING ON FLOOR THIS LAMP FEATURES WITH ITS EXPRESSIVE POWER ANY TYPE OF ENVIRONMENT.

TECHNICAL DRAWINGS



UTILIZATION: INTERNAL		TPOLOGY: TABLE LAMPS 	
COLOURS	STRUCTURE: DIFFUSER:	SATIN ALUMINIUM WHITE	
MATERIALS	STRUCTURE: DIFFUSER:	STAINLESS STEEL OPAL WHITE METHACRYLATE	
MEASURES	WIDTH: - HEIGHT: 66 - 86 cm LENGTH: - DEPTH: -	DIAMETER: 55 cm HOLE DIAMETER: - HOLE DEPTH: -	WEIGHT NET: 10 GROSS: 14
	PACKAGING VOL.M ³ : 54X54X26 - 41X41X78		NUMBER OF ITEMS: 2
BULBS	LED 4X5W E14 FLUX: 1880LM KELVIN: 2700° CLASS: A+ CRI: >80 COLOR TOLERANCE: - DURATION: 25000H		
			
DEVICE SPECIFICATIONS			
TYPE OF EMISSION: DIFFUSED		POWER SUPPLY CABLE LENGTH: 45+200cm	
POWER: -		LENGTH OF HANGING CABLE: -	
FLOW LAMP: -		SUPPLY: -	
BEAM ANGLE: -		POWER SUPPLY ASSEMBLY: -	
DEVICE EFFICIENCY: -lm/W		TYPE OF DIMMING: -	
IMPACT RESISTANCE: -		VOLTAGE: 230 V	
GLOW WIRE TEST: -		POWER SUPPLY: -	
CERTIFICATIONS			
MARKETS	THIS ITEM IS AVAILABLE IN THE FOLLOWING COUNTRIES: EUROPE		

PIPISTRELLO
code: **620/AL**

DESIGN **GAE AULENTI** 1965

PHOTO GALLERY



PIPISTRELLO

code: **620/BI**







DESIGN **GAE AULENTI** 1965

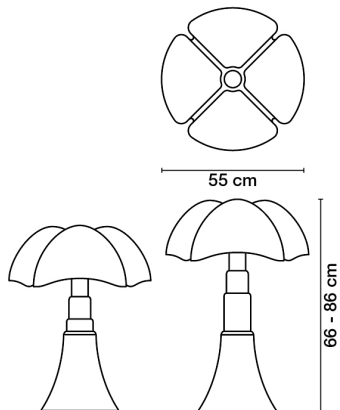

TABLE OR STANDING LAMP WITH DIFFUSED LIGHT, ADJUSTABLE HEIGHT WITH TELESCOPIC MOVEMENT. DIFFUSER IN WHITE OPAL METHACRYLATE. STAINLESS STEEL TELESCOPE. PAINTED METAL BASE AND KNOB IN DARK BROWN /MA, WHITE /BI, PURPLE RED /RO, GLOSSY BLACK /NE AND SATIN ALUMINIUM /AL. DESIGNED IN 1965 BY GAE AULENTI FOR MARTINELLI LUCE, THE LAMP IS MADE WITH INNOVATIVE TECHNIQUES FOR THE DIFFUSER IN METHACRYLATE FOR THE TIME IN WHICH IT WAS DESIGNED. THE SHAPE OF CONIC BASE GROWS IN THE HEIGHT THROUGH THE RIBS OF THE DIFFUSER AS THE WINGS OF A BAT. RESTING ON A TABLE OR STANDING ON FLOOR THIS LAMP FEATURES WITH ITS EXPRESSIVE POWER ANY TYPE OF ENVIRONMENT.

TECHNICAL DRAWINGS



UTILIZATION: INTERNAL		TPOLOGY: TABLE LAMPS 	
COLOURS	STRUCTURE: DIFFUSER:	WHITE WHITE	
MATERIALS	STRUCTURE: DIFFUSER:	STAINLESS STEEL OPAL WHITE METHACRYLATE	
MEASURES	WIDTH: - HEIGHT: 66 - 86 cm LENGTH: - DEPTH: -	DIAMETER: 55 cm HOLE DIAMETER: - HOLE DEPTH: -	WEIGHT NET: 10 GROSS: 14
PACKAGING VOL.M ³ : 54X54X26 - 41X41X78		NUMBER OF ITEMS: 2	
BULBS	LED 4X5W E14 FLUX: 1880LM KELVIN: 2700° CLASS: A+ CRI: >80 COLOR TOLERANCE: - DURATION: 25000H		
			
DEVICE SPECIFICATIONS			
TYPE OF EMISSION: DIFFUSED		POWER SUPPLY CABLE LENGTH: 45+200cm	
POWER: -		LENGTH OF HANGING CABLE: -	
FLOW LAMP: -		SUPPLY: -	
BEAM ANGLE: -		POWER SUPPLY ASSEMBLY: -	
DEVICE EFFICIENCY: -lm/W		TYPE OF DIMMING: -	
IMPACT RESISTANCE: -		VOLTAGE: 230 V	
GLOW WIRE TEST: -			
POWER SUPPLY: -			
CERTIFICATIONS	    		
MARKETS	THIS ITEM IS AVAILABLE IN THE FOLLOWING COUNTRIES: EUROPE		

PIPISTRELLO
code: *620/BI*

DESIGN **GAE AULENTI** 1965

PHOTO GALLERY



PIPISTRELLO
code: **620/MA**



DESIGN **GAE AULENTI** 1965

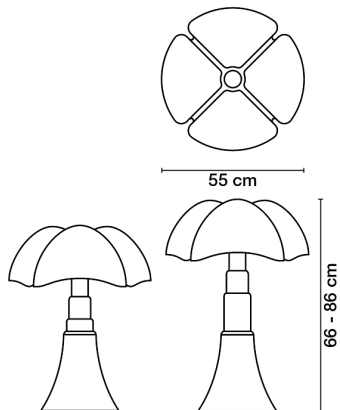

TABLE OR STANDING LAMP WITH DIFFUSED LIGHT, ADJUSTABLE HEIGHT WITH TELESCOPIC MOVEMENT. DIFFUSER IN WHITE OPAL METHACRYLATE. STAINLESS STEEL TELESCOPE. PAINTED METAL BASE AND KNOB IN DARK BROWN /MA, WHITE /BI, PURPLE RED /RO, GLOSSY BLACK /NE AND SATIN ALUMINIUM /AL. DESIGNED IN 1965 BY GAE AULENTI FOR MARTINELLI LUCE, THE LAMP IS MADE WITH INNOVATIVE TECHNIQUES FOR THE DIFFUSER IN METHACRYLATE FOR THE TIME IN WHICH IT WAS DESIGNED. THE SHAPE OF CONIC BASE GROWS IN THE HEIGHT THROUGH THE RIBS OF THE DIFFUSER AS THE WINGS OF A BAT. RESTING ON A TABLE OR STANDING ON FLOOR THIS LAMP FEATURES WITH ITS EXPRESSIVE POWER ANY TYPE OF ENVIRONMENT.

TECHNICAL DRAWINGS



UTILIZATION: INTERNAL		TPOLOGY: TABLE LAMPS 	
COLOURS	STRUCTURE: DIFFUSER:	DARK BROWN WHITE	
MATERIALS	STRUCTURE: DIFFUSER:	STAINLESS STEEL OPAL WHITE METHACRYLATE	
MEASURES	WIDTH: - HEIGHT: 66 - 86 cm LENGTH: - DEPTH: -	DIAMETER: 55 cm HOLE DIAMETER: - HOLE DEPTH: -	WEIGHT NET: 10 GROSS: 14
	PACKAGING VOL.M ³ : 54X54X26 - 41X41X78		NUMBER OF ITEMS: 2
BULBS	LED 4X5W E14 FLUX: 1880LM KELVIN: 2700° CLASS: A+ CRI: >80 COLOR TOLERANCE: - DURATION: 25000H		
			
DEVICE SPECIFICATIONS			
TYPE OF EMISSION: DIFFUSED		POWER SUPPLY CABLE LENGTH: 45+200cm	
POWER: -		LENGTH OF HANGING CABLE: -	
FLOW LAMP: -		SUPPLY: -	
BEAM ANGLE: -		POWER SUPPLY ASSEMBLY: -	
DEVICE EFFICIENCY: -lm/W		TYPE OF DIMMING: -	
IMPACT RESISTANCE: -		VOLTAGE: 230 V	
GLOW WIRE TEST: -		POWER SUPPLY: -	
CERTIFICATIONS			
MARKETS	THIS ITEM IS AVAILABLE IN THE FOLLOWING COUNTRIES: EUROPE		

PIPISTRELLO
code: *620/MA*

DESIGN **GAE AULENTI** 1965

PHOTO GALLERY

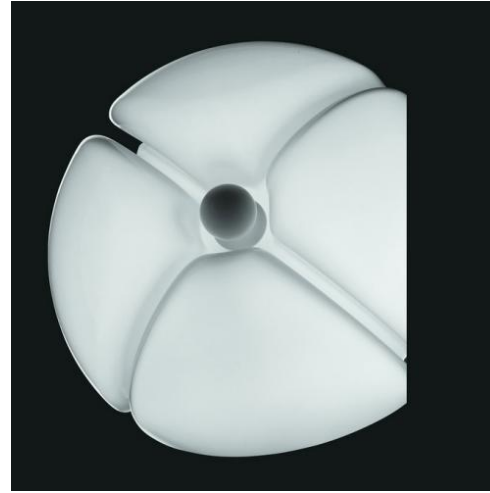

PIPISTRELLO
code: **620/NE**







DESIGN **GAE AULENTI** 1965

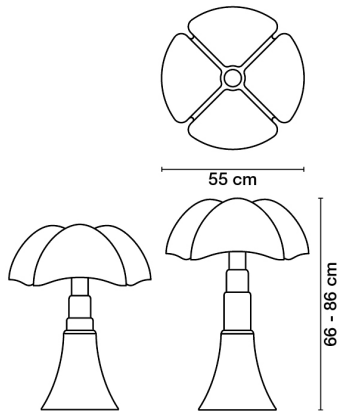

TABLE OR STANDING LAMP WITH DIFFUSED LIGHT, ADJUSTABLE HEIGHT WITH TELESCOPIC MOVEMENT. DIFFUSER IN WHITE OPAL METHACRYLATE. STAINLESS STEEL TELESCOPE. PAINTED METAL BASE AND KNOB IN DARK BROWN /MA, WHITE /BI, PURPLE RED /RO, GLOSSY BLACK /NE AND SATIN ALUMINIUM /AL. DESIGNED IN 1965 BY GAE AULENTI FOR MARTINELLI LUCE, THE LAMP IS MADE WITH INNOVATIVE TECHNIQUES FOR THE DIFFUSER IN METHACRYLATE FOR THE TIME IN WHICH IT WAS DESIGNED. THE SHAPE OF CONIC BASE GROWS IN THE HEIGHT THROUGH THE RIBS OF THE DIFFUSER AS THE WINGS OF A BAT. RESTING ON A TABLE OR STANDING ON FLOOR THIS LAMP FEATURES WITH ITS EXPRESSIVE POWER ANY TYPE OF ENVIRONMENT.

TECHNICAL DRAWINGS



UTILIZATION: INTERNAL		TPOLOGY: TABLE LAMPS 	
COLOURS	STRUCTURE: DIFFUSER:	BLACK WHITE	
MATERIALS	STRUCTURE: DIFFUSER:	STAINLESS STEEL OPAL WHITE METHACRYLATE	
MEASURES	WIDTH: - HEIGHT: 66 - 86 cm LENGTH: - DEPTH: -	DIAMETER: 55 cm HOLE DIAMETER: - HOLE DEPTH: -	WEIGHT NET: 10 GROSS: 14
PACKAGING VOL.M ³ : 54X54X26 - 41X41X78		NUMBER OF ITEMS: 2	
BULBS	LED 4X5W E14 FLUX: 1880LM KELVIN: 2700° CLASS: A+ CRI: >80 COLOR TOLERANCE: - DURATION: 25000H		
			
DEVICE SPECIFICATIONS			
TYPE OF EMISSION: DIFFUSED		POWER SUPPLY CABLE LENGTH: 45+200cm	
POWER: -		LENGTH OF HANGING CABLE: -	
FLOW LAMP: -		SUPPLY: -	
BEAM ANGLE: -		POWER SUPPLY ASSEMBLY: -	
DEVICE EFFICIENCY: -lm/W		TYPE OF DIMMING: -	
IMPACT RESISTANCE: -		VOLTAGE: 230 V	
GLOW WIRE TEST: -			
POWER SUPPLY: -			
CERTIFICATIONS	    		
MARKETS	THIS ITEM IS AVAILABLE IN THE FOLLOWING COUNTRIES: EUROPE		

PIPISTRELLO
code: **620/NE**

DESIGN **GAE AULENTI** 1965

PHOTO GALLERY

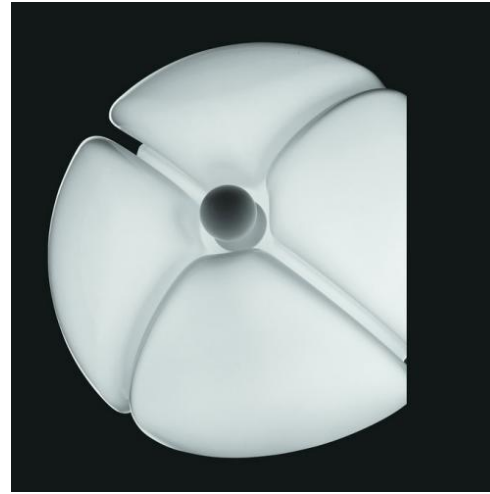

PIPISTRELLO
code: **620/RO**







DESIGN **GAE AULENTI** 1965

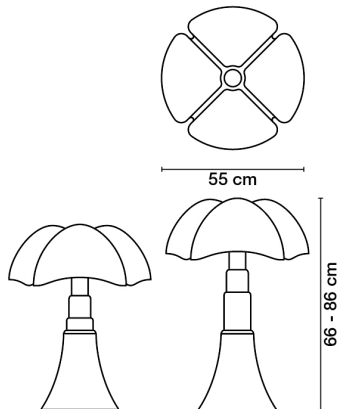

TABLE OR STANDING LAMP WITH DIFFUSED LIGHT, ADJUSTABLE HEIGHT WITH TELESCOPIC MOVEMENT. DIFFUSER IN WHITE OPAL METHACRYLATE. STAINLESS STEEL TELESCOPE. PAINTED METAL BASE AND KNOB IN DARK BROWN /MA, WHITE /BI, PURPLE RED /RO, GLOSSY BLACK /NE AND SATIN ALUMINIUM /AL. DESIGNED IN 1965 BY GAE AULENTI FOR MARTINELLI LUCE, THE LAMP IS MADE WITH INNOVATIVE TECHNIQUES FOR THE DIFFUSER IN METHACRYLATE FOR THE TIME IN WHICH IT WAS DESIGNED. THE SHAPE OF CONIC BASE GROWS IN THE HEIGHT THROUGH THE RIBS OF THE DIFFUSER AS THE WINGS OF A BAT. RESTING ON A TABLE OR STANDING ON FLOOR THIS LAMP FEATURES WITH ITS EXPRESSIVE POWER ANY TYPE OF ENVIRONMENT.

TECHNICAL DRAWINGS



UTILIZATION:	INTERNAL	TIPOLOGY:	TABLE LAMPS	
COLOURS	STRUCTURE: DIFFUSER:	PURPLE RED WHITE		
MATERIALS	STRUCTURE: DIFFUSER:	STAINLESS STEEL OPAL WHITE METHACRYLATE		
MEASURES	WIDTH: - HEIGHT: 66 - 86 cm LENGTH: - DEPTH: -	DIAMETER: 55 cm HOLE DIAMETER: - HOLE DEPTH: -	WEIGHT NET: 10 GROSS: 14	
	PACKAGING VOL.M ³ : 54X54X26 - 41X41X78		NUMBER OF ITEMS: 2	
BULBS	LED 4X5W E14 FLUX: 1880LM KELVIN: 2700° CLASS: A+ CRI: >80 COLOR TOLERANCE: - DURATION: 25000H			
DEVICE SPECIFICATIONS	TYPE OF EMISSION: DIFFUSED POWER: - FLOW LAMP: - BEAM ANGLE: - DEVICE EFFICIENCY: -lm/W IMPACT RESISTANCE: - GLOW WIRE TEST: -	POWER SUPPLY CABLE LENGTH: 45+200cm LENGTH OF HANGING CABLE: - SUPPLY: - POWER SUPPLY ASSEMBLY: - TYPE OF DIMMING: - VOLTAGE: 230 V		
CERTIFICATIONS	    			
MARKETS	THIS ITEM IS AVAILABLE IN THE FOLLOWING COUNTRIES: EUROPE			

PIPISTRELLO
code: *620/RO*

DESIGN **GAE AULENTI** 1965

PHOTO GALLERY

